

TUBE DIMENSIONS

It will be noted that with each tube type there appears a tube outline drawing showing the style of bulb and base employed. In the tabulations of characteristics the type of bulb is specified by a symbol and the style of base is also listed. Whenever it is desired to know the tube dimensions pertaining to any particular tube, reference may be made to the complete group of tube outlines on pages 24 to 28 which show all important dimensions.

ST-12 STYLE

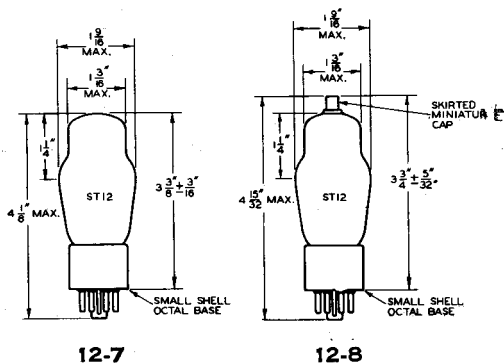
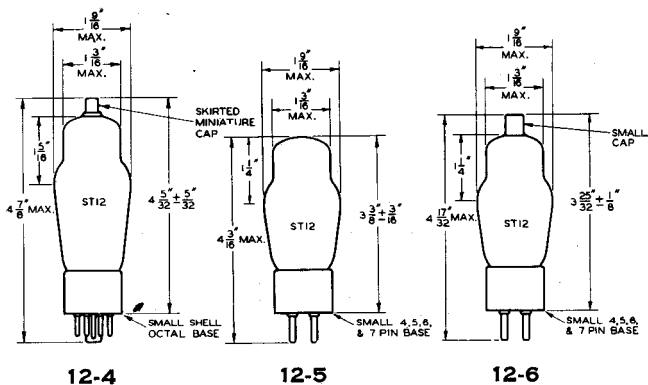
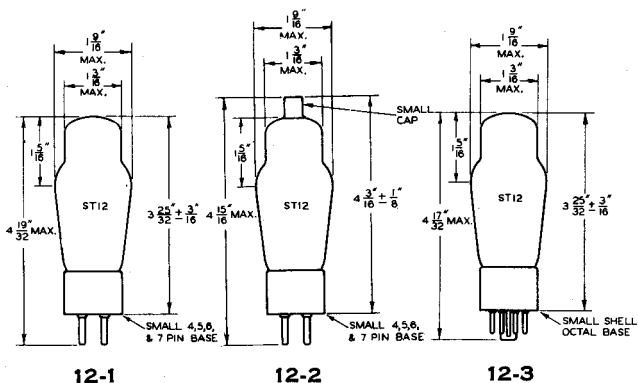

TUBE DIMENSIONS

LARGER ST STYLES

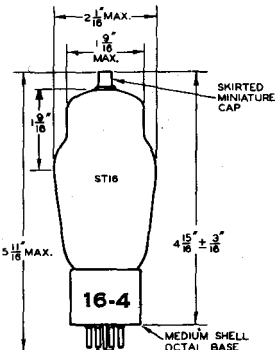
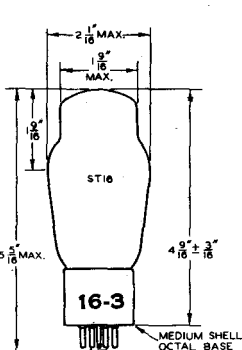
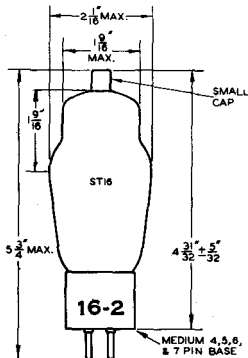
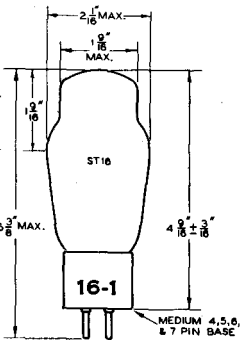
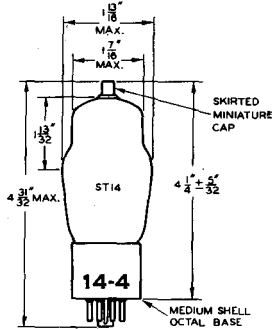
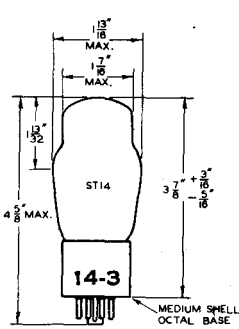
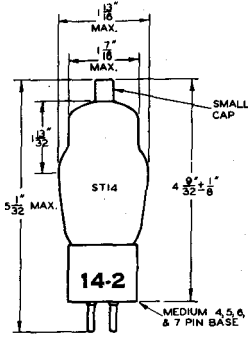
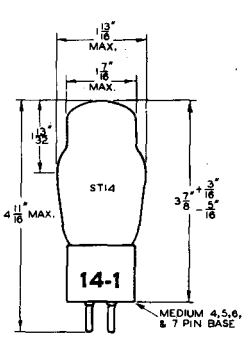

TUBE DIMENSIONS

T9 STYLE

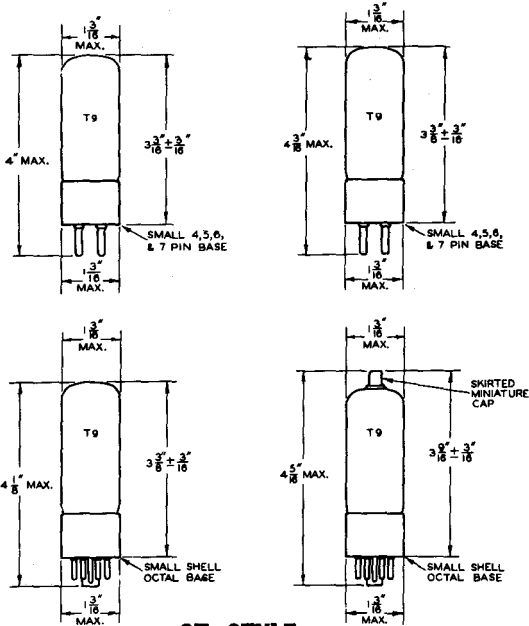

GT STYLE

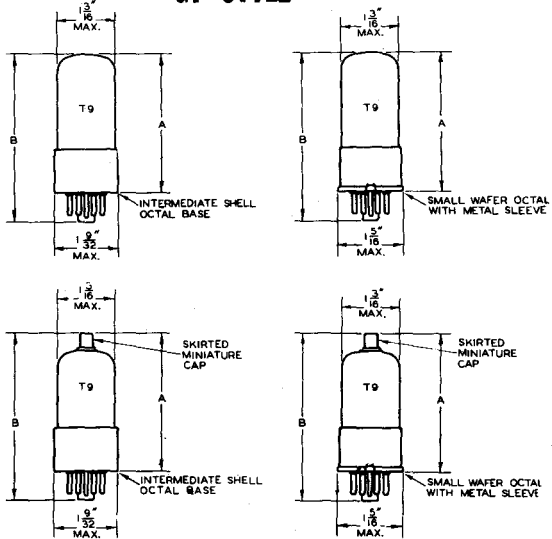

DIMENSIONS "A" AND "B" ARE GIVEN AS SEATED HEIGHT AND OVERALL LENGTH RESPECTIVELY FOR EACH INDIVIDUAL TYPE.

TUBE DIMENSIONS

LOCK-IN STYLE

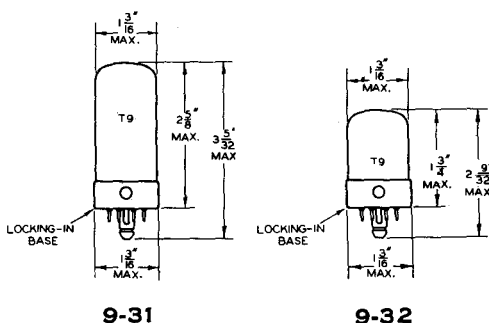
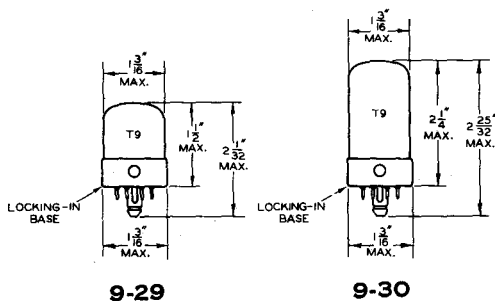

MINIATURE STYLE

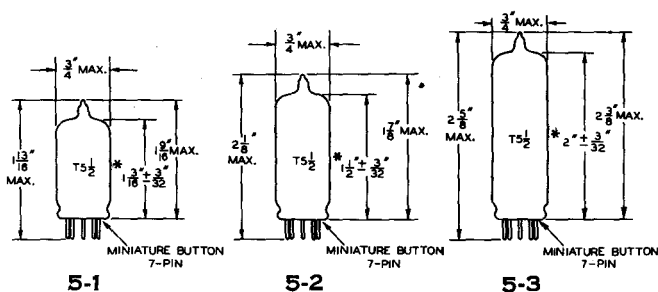

* MEASURED FROM BASE SEAT TO BULB-TOP LINE AS DETERMINED BY RING GAUGE OF $\frac{1}{16}$ " I.D.

The construction of the T6½ type is comparable to that of the T5½ types 5-2 and 5-3. The major differences are the bulb diameters and bases, the T6½ having a 9 pin base and a ⅞" maximum bulb diameter.

TUBE DIMENSIONS

METAL STYLE

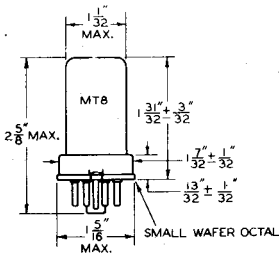

8-1

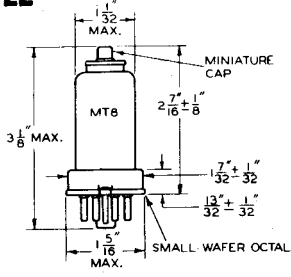

8-2

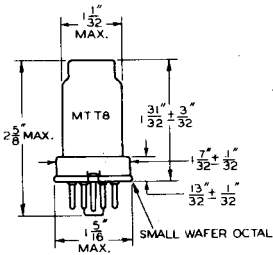

8-3

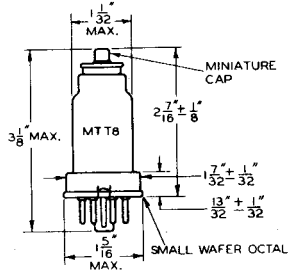

8-4

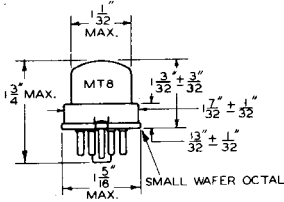

8-5

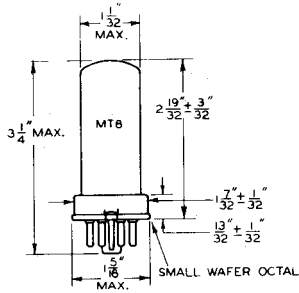

8-6

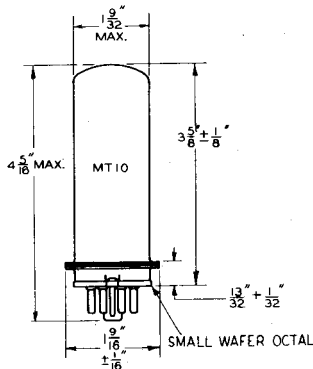

10-1